

Metallurgy development: Discovery and utilization of aluminum through history

Kozina, Franjo; Zovko Brodarac, Zdenka

Source / Izvornik: "Engineering Power" - Bulletin of the Croatian Academy of Engineering, 2023, 17, 6 - 19

Journal article, Accepted version

Rad u časopisu, Završna verzija rukopisa prihvaćena za objavljivanje (postprint)

Permanent link / Trajna poveznica: <https://um.nsk.hr/um:nbn:hr:115:071511>

Rights / Prava: [In copyright](#) / [Zaštićeno autorskim pravom](#).

Download date / Datum preuzimanja: **2024-07-04**



SVEUČILIŠTE U ZAGREBU
METALURŠKI FAKULTET
UNIVERSITY OF ZAGREB
FACULTY OF METALLURGY

Repository / Repozitorij:

[Repository of Faculty of Metallurgy University of Zagreb - Repository of Faculty of Metallurgy University of Zagreb](#)



Kozina Franjo¹, Zovko Brodarac Zdenka¹

Metallurgy development: Discovery and utilization of aluminum through history

¹University of Zagreb Faculty of Metallurgy, Aleja narodnih heroja 3, Sisak, Croatia

Abstract

Since the early human civilizations, the discovery and use of new materials and the development of new technologies have changed culture and influenced the development of the modern human environment. At the same time, innovations based on scientific discoveries and technological advances are connected to increasingly complex social and political structures and international relations, which have an impact on economic growth and social benefits. Unfortunately, the human capacity for technological and strategic innovation has most often been demonstrated under stressful conditions inspiring the phrase “necessity is the mother of invention”. The goal of this review is to examine the necessity that compelled mankind to search for metals, primarily focusing on the discovery of aluminum and the challenges represented by the complex nature of its minerals. Although men’s first contact with metal initiated with native copper and meteoritic iron, bronze was the first metallic material significantly impacting human society. The experiments with its chemical composition led to the development of metallurgical processes such as smelting, refining, and casting as well as mechanisms of economics and communication. The accidental discovery of iron in the process of copper ore refining gave mankind greater control over its environment, resulting in increased population and expanded settlements. Aluminum, as a brilliant white metal, was introduced to the world through the works of Wöhler and Deville. However, it became commercially available after electrolysis was discovered by Charles Martin Hall on February 23rd 1886 in a woodshed using home-made battery. A few months later, the similar results were obtained by Paul Louis Toussaint Héroult, so the process for electrolytic production of aluminum bears both of their names. As a symbol of modernity aluminum is used today in the automotive, aerospace, railway, marine, electric, and architectural applications. At the end of this work, it is superfluous to ask whether humanity would have been able to explore the universe and reach the stars if it had been restricted by stone, bones and wood.

Keywords: history of metallurgy, human society, aluminum

1. Introduction

Since the beginning of human civilization, the discovery of new materials and the development of new technologies have changed culture and influenced the development of the modern human environment [1]. In archeological studies this relationship is described by the term “material of past cultures” [2], referring to the materials that were produced, used, purchased or consumed [3]. This term is based on the fact that social conditions as well as the social status of an individual can be reflected in physical objects [4]. Given that innovation based on scientific discoveries and technological breakthroughs is a dynamic process, their impact on economic growth and social benefits is not surprising [5,6]. In historical context a general increase in technological complexity, diversity, and efficiency has been correlated with increasingly complex social and political units of organization [7]. However, the cross-cultural view shows that the changes in social values, social norms, patterns of organizational behavior as well as the power and authority have frequently ended in conflict or war [8]. As one of the causal variables, the conflict has inspired the idea that humans have an inherent capacity for technological and strategic innovation under stressful conditions. This view is summed up in the hopeful phrase “Necessity is the mother of invention” [9] and represents one of the earliest cultural models of evolution [7].

The purpose of this paper is to examine the need that forced mankind to search for metals, and the impact of

metallurgy on the development of human society. The paper focuses primarily on the discovery of aluminum (Al) and the challenges posed by the complex nature of Al-containing minerals as well as the need for interdisciplinary approach to the development of an industrially sustainable Al production process.

2. The evolution of early metallurgy

The evolution of metallurgy (**Fig. 1.**) and material sciences in general includes an artistic, industrial, and scientific approach. The artistic notion was inspired by initial realization that different materials behave differently. The different types of industrial and social organizations at different times were sparked by the need for large-scale production due to the useful properties of the materials. Ultimately, the need to achieve an optimal balance between properties and application led to the development of a science that permitted the selection of chemical composition and the manipulation of structure at many levels - metallurgy [10]. The history of metallurgy was determined by the availability of metals. It started with the utilization of native metals and developed with the knowledge of how to create an environment with higher temperatures to enable the smelting of ores, melting, and alloying of metals [12]. Consequently, early metallurgy began with the use of native copper (Cu) and meteoritic iron (Fe). While the rarity of meteoritic iron (*amūtu* [13]) limited its application to ritualistic and embellishment purposes [14], the shaping and annealing of Cu represented the next step in the development of metallurgy (**Fig. 1.**) [14, 15]. The early use of native Cu

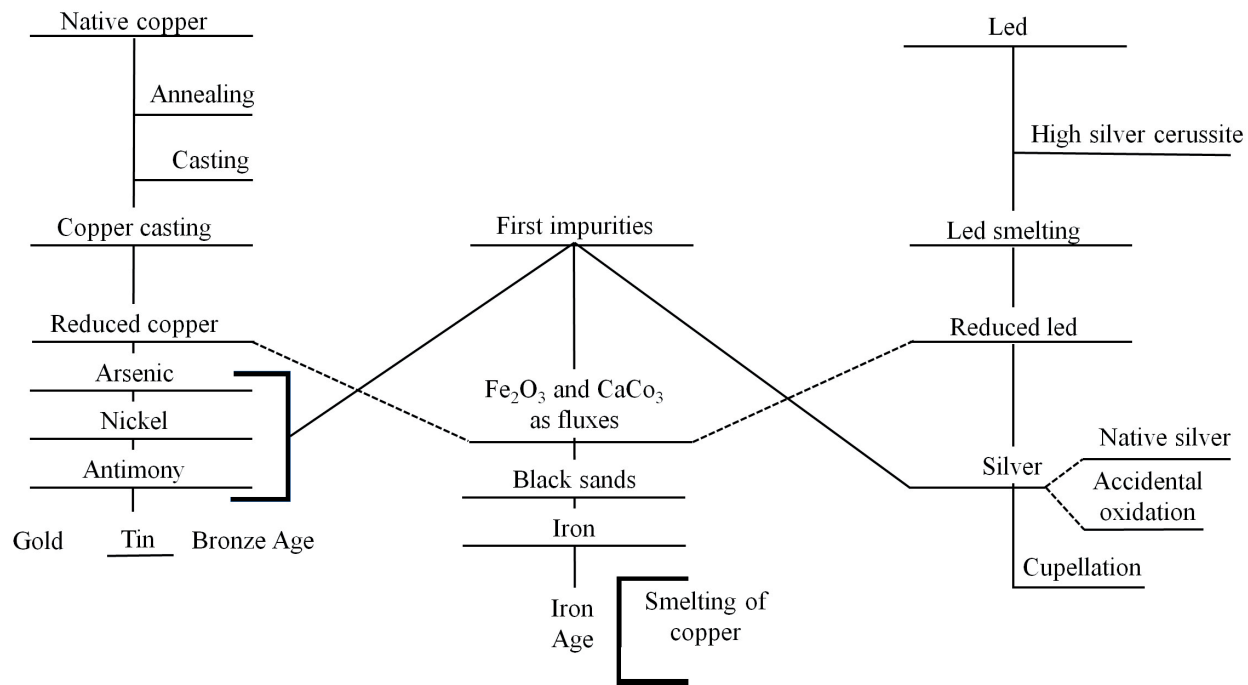

Fig. 1. Schematic tree of the development of metallurgy [11]

involved the use of an extremely limited Stone Age technique of cold forming to produce beads and possibly awls, pins, or hoops [17]. The complexity of the early design increased with the use of annealing. In this process, native Cu was exposed to a gentle heat that resulted in a softening of the material. The casting of native Cu occurred accidentally when it was exposed to temperatures over 1083 °C during annealing. The melted pieces of copper solidified in a single puddle (*puddle casting*), which allowed the reuse of the scrap and increased the availability of metal [18]. The appearance of *puddle casting* indicated that the early artisans almost simultaneously followed two important courses of discovery. The first course dealt with the shaping and melting of the native metals. At some unknown point in history, smiths realized that Cu, lead (Pb), silver (Ag) and zinc (Zn) can be found in sulfide ores developing techniques of roasting, matting and fire refining [19]. The first use of iron by pre-Hittite and Hittite people of Anatolia and Mesopotamia around 1500 BCE was the culminating moment in both pyrotechnological and early metallurgical processing [11]. Compared to modern pyrometallurgy, pyrotechnology involved the use of fire by humans to produce plasters, ceramic pots and bricks, glazes, glasses and metals in a temperature range between 100 °C to 1500 °C [20, 21, 22]. While the temperature of 100 °C was used for roasting gypsum to make plaster of paris [23], the temperature of 1100 °C was used to cast native Cu, extract most metals from ores, and vitrify pots to a kind of a glaze [18]. As shown in Fig. 1, the smelting of terrestrial Fe (*ašī'u* [13]) was a derivative of large-scale smelting of Cu and Pb from sulfide ores using Fe-containing flux [24]. The smelting of Pb ores with the addition of hematite (Fe₂O₃) or gossan [25] fluxes sometimes yielded a mass of unfused Fe known as “bear” as a consequence of high heat and the excessive use of fluxes. Pure Fe was also yielded during the smelting of covellite (CuS) or chal-

cocite (Cu₂S) ore with a use of gossan flux [26, 27]. The early Turkish experiments showed that iron could be obtained in industrially usable form by carefully controlling smelting temperature in order to keep it in a spongy state [15]. The iron ore and wood were put into a furnace to burn. The reaction between carbon and the oxygen from the Fe ore enabled the reduction of Fe in the form of a spongy mass. This mass contained slag that was mostly removed by hammering to produce wrought Fe and shape it into a tool. While Turkish metallurgists were not able to generate enough heat to produce Fe castings [12], better furnaces and Fe ores with higher phosphorus content enabled the production of cast iron in China as early as 3rd century BCE [28]. The appearance of polymetallism and the awareness of the beneficial effect of alloying resulted from the development of smelting techniques. Early alloying systems were developed through the use of complex ores (especially sulfides and gossans), techniques of fluxing ores with each other and the discovery of active impurities during casting (native Cu) and smelting. As shown by the discovery of Fe, smelting did not begin with the reduction of a single metal from the ore, but with an attempt to reduce several metallic ores with one fluxing the other [11]. While Ag accidentally occurred as an impurity during Pb refining by cupellation [29], [30] (Fig. 1), arsenic (As) was detected in the vicinity of Cu deposits. Consequently, it became known for its silvering effect observed in many Eurasian bronzes of the 3rd and early 2nd millennia [31]. In the range of 0.25 % to 12.0 %, As seems to have been the most consistent impurity forcing early metallurgist to search for an adequate alloying element – tin (Sn). Considering that the origins of Sn in Anatolia, Mesopotamia, and Iran are still not completely clear, its use remains the mystery of bronze metallurgy (Fig. 1.) [11]. Today, it is assumed that Sn was supplied by two main routes. The first involved the trade of hundreds of kilograms of

Sn moving from Aššur in Assyria to Kamiš in Anatolia, while the other progressed from Susa to a site identified as Crete by the way of Euphrates. This assumption is supported by philological analysis of documents containing the word *annaku* meaning tin [32, 33]. Up to this point, the social and cultural consequences of metallurgy development can be considered as minor. Since Cu was too soft a material to replace stone tools and weapons used in Neolithic times [34], its primary purpose was ornamental [17]. The first bronze, as an alloy produced by adding tin to copper, has a predecessor of approximately the same hardness and strength in the so-called arsenic or antimony copper, or as many consider arsenic/antimony bronze, which as a formation was created from a complex ore - tennantite $((\text{Cu,Fe})_{12}\text{As}_4\text{S}_{13})$ and tetrahedrite $((\text{Cu,Fe})_{12}\text{Sb}_4\text{S}_{13})$. Furthermore, the experimentation with bronze chemical composition led to the development of metallurgical processes such as smelting, refining and casting as well as mechanisms of economics and communication [35]. The archeological discoveries in Kültape and its satrapies [36] represent the evidence of organized production of Cu from sulfide ores, the first large-scale trade in the rare metal Sn, the fabrication of bronze by industrial methods, the output of Ag, experimentation with Fe as well as the extensive use of mechanisms of economics such as banking, crediting and keeping of complex records [37, 38]. These documents describe the expansion of metal trading area deep into Europe and western Asia. In the middle of the 2nd century BC, the search for the most elusive and sought-after metal Sn led men as far as Cornwall in England [39]. The penetration of sulfide technology to Cu deposits of Cyprus and Pb deposits in Greece marked the beginning of mass production [40]. Consequently, the Cu billets of Cyprus in the shape of ox hide are considered to be the trademark of this period (**Fig. 2**) [41].



Fig. 2. Copper ox-hide ingot dating to the Late Bronze Age discovered at the Enkomi in Cyprus [41]

Thanks to the development of smelting techniques, Fe replaced bronze as a principal material in tool and weapon production. The utilization of iron gave mankind greater control of its environment leading to the increased population and larger settlements. It was not until the 14th century that iron smelting furnaces, known as blast furnaces, were built in Europe. The blast furnaces had water powered bellows that produced much higher temperatures allowing iron to absorb smaller quantities of carbon (C). Consequently, the *pig iron* could be obtained at a lower smelting temperature and directly poured into molds [42]. The substantial improvements to the blast furnaces refer-

ring to increased high stack due to the higher pressure of the blast, but also a change in stack geometry, enabled a continuous smelting process with increased efficiency and productivity. A further reduction in C content and the transition from *pig* to *wrought iron* was obtained in reverberatory furnaces through the works of Henry Cort and James Neilsen [43, 44]. *Wrought iron* was the principal material of Industrial Revolution until the second half of the 19th century when a process was invented to produce cheaper steel. The Bessemer process involved blowing air through the bottom of a vessel called converter containing liquid *pig iron* [45]. Oxygen (O_2) from the air combined with Fe to produce iron oxide (FeO) that reacted with C from the *pig iron* to produce carbon monoxide (CO). The reduction in C content is a consequence of the reaction between CO and C from pig iron. The remaining C is additionally removed when the O_2 from air is combined with silicone (Si) and manganese (Mn) to form slag. Since the resulting steel was brittle, the chemical composition needed to be amended with the addition of Mn and C [46]. An alternative method of making steel known as the *open-hearth process* was invented in 1864 by the William and Frederic Siemens and improved by the Pierre and Emile Martin. The furnace chambers known as regenerators were alternatively heated by the furnace gases leading to higher temperatures. Similar to the Bessemer process, FeO and CO were used to reduce C and remove impurities. Although it took longer to achieve better control over C content, open-hearth process enabled a reduction in phosphorus (P) content and decrease in non-metallic inclusion content. The optical micrographs of the steel produced by early Bessemer and *open-hearth process* are shown in **Fig. 3**.

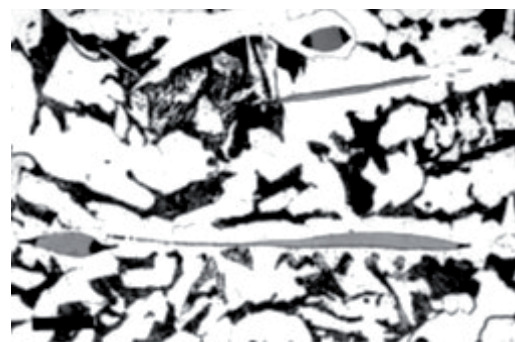

a)

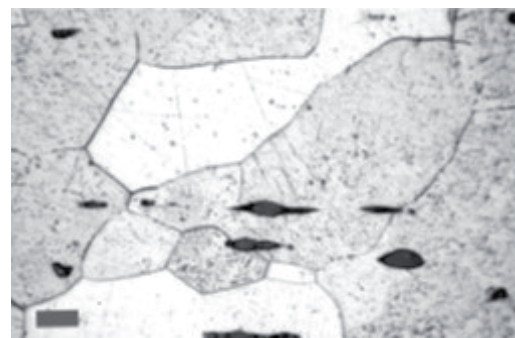

b)

Fig. 3. The optical micrographs of:
a) Brooklyn Bridge steel showing manganese sulfide (MnS),
b) Springfield Barrel steel showing MnS inclusions with silicate ends [47]

The metallographic analysis performed on the Brooklyn Bridge steel produced by the early Bessemer process revealed the presence of large complex non-metallic inclusions consisting of MnS and manganese silicate (Fig. 3. a). The reduction in size and content of non-metallic inclusions in Springfield Barrel steel produced by *open-hearth process* (Fig. 3. b) was a consequence of the prolonged deoxidation time allowing impurities to form slag on the surface of the melt [47]. The Bessemer and *open-hearth* production processes reduced the price and increased the production of steel. Cheaper steel replaced iron in a variety of applications such as railway, shipyard, and bridge building [12].

The early models were classified as arc radiation or arc conduction furnaces. The Stassano furnace developed in Italy was one of the first models of arc radiation furnaces initially used in the experimental reduction of iron ores (Fig. 4.)

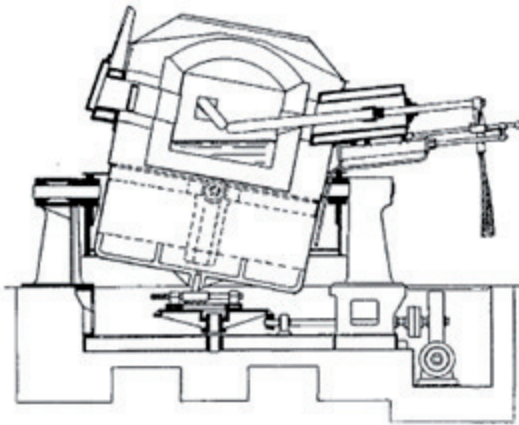

Fig. 4. Stassano furnace [48]

Its three electrodes slightly inclined at an angle of 120° enabled easy regulation and steady load even when using cold input materials. However, the utilization of Stassano furnace was limited by its low heat-efficiency and use of a tap-hole. The second type of electric arc furnace is considered more efficient because in addition to passing through the electrodes, the electrical energy also passed through the input material. However, one of the first models known as Héroult furnace exhibited significant surface instability of the melt preventing its use in the production of higher quality steel [48].

Despite being more expensive than Bessemer and *open-hearth procedure*, the electric arc furnace enabled better control of temperature and production of higher quality steel [12]. It was extensively used during World War One in the production of alloyed steels for ordinance purposes. In the post-war period, the arc technology allowed for quick rebuilding and revitalization of Europe. Mower, it enabled European manufactures to effectively compete with large steelworks of the United States in the production of cheap carbon steel [49]. Presently, it is commonly used for the production of stainless and manganese steel as well as a whole range of low alloy steels for the automotive and aircraft industry [50].

The further development of electric furnace technology enabled the large-scale production of metals such as tungsten (W), chromium (Cr) and Mn as well as the mass production of Al [46].

3. Discovery of aluminum

Although it is only one hundred and sixty years since Al was discovered in its elemental form, and only one hundred years since a viable manufacturing process was established, more Al is now produced annually than all other non-ferrous metals combined [51]. In 2021, 67,092 thousand metric tons of primary Al was produced with a daily average of 183.8 thousand metric tons. The leading producer of primary aluminum in 2021 was China with 38,837 thousand metric tons followed by Gulf Cooperation Council consisting of Bahrain, Oman, Qatar, Saudi Arabia, and United Arab Emirates with 5,889 thousand metric tons [52].

The scientific and technological application of Al and its alloys began during the Industrial Revolution in the late 19th and early 20th century with the development of automotive, railway and marine industries. However, the Al alloys had the greatest impact on the aerospace industry. Due to their low cost, easy fabrication, light weight and the high-strength levels achievable through the heat treatment, Al alloys become the main aircraft material since they started replacing wood in the late 1920s [53]. In order to meet the requirements of the contemporary aerospace industry low structural weight, higher damage tolerance, and higher durability, further improvements in fracture toughness, fatigue performance, formability and superplasticity [54] have been achieved [55]. Simultaneously, Al and Al alloys have found application in different branches of industry.

3.1. The main obstacles in the discovery of aluminum

Because it does not occur naturally in its native form, Al was discovered late. Instead, Al constitutes 8.2 % of the earth's crust in the form of Al-bearing ores such as alum (potassium aluminum sulfate), feldspars (sodium aluminum silicate), micas (aluminum silicates), clayey earths (aluminum silicates) and bauxite [56]. As a consequence, in their attempt to synthesize elemental Al, the first researchers were not only confronted with the complex nature of the Al-bearing minerals, but also with the need for interdisciplinary engineering and scientific approach to the development of industrially viable process for Al extraction, reduction and manufacturing [57]. Although the synthesis of elemental Al required a contemporary approach, the use of its minerals began in ancient times.

3.2. Ancient history

The concept that all matter is composed of particles too small to be seen was introduced in ancient Greece by Leucippus and Democritus. They assumed that atoms are homogeneous and completely solid with different sizes, shapes and weights [59]. Regardless of his aversion towards Leucippus and Democritus theory, their work allowed Aristotle to define the nature of the element [60]. His theory was important for understanding the results

of experiments performed by the early metalworkers and craftsmen. They have learned that regardless of the extraction result, the process could be reversed without permanently affecting the basic element. To the ancient world that was aware of Ag, Au, Cu, C and S and was struggling to extract Pb, Sn, Hg and Fe, aluminum could be connected through the alum ($KAl(SO_4)_2 \cdot 12H_2O$). When clay reacts with sulfuric acid from damp volcanic earth, alum is produced. Consequently, its deposits are located near the surface and easily mined. In the ancient civilizations of Mesopotamia, Sumeria, Egypt, Greece and Rome, alum was mainly used for medical purposes. Alum was also used by ancient metalworkers in Au purification, surface enrichment of Ag alloys and artificial patination process [61]. The Egyptian black-patinated statuette of a cat is shown in Fig. 5.



Fig. 5. The Egyptian black-patinated statuette of a cat exhibited in the Los Angeles County Museum of Art [61]

The statuette was made from Cu alloy containing approximately 1% Au and 1% Ag. The statuette was inlaid with Ag and patinated in the chemical bath composed of Cu salts, alum and vinegar [61]. The alum extraction process and its application are best described in the encyclopedic work of Pliny the Elder entitled *Naturalis Historia*. In the book 35 chapter 52 named *Alumen and the several varieties of it; Thirty eight remedies*, Pliny recalls the story of a strange, light, silvery metal obtained from plain clay, insinuating the possibility that Al may have been discovered by accident 2000 years ago. One day, a goldsmith in Rome was allowed to show the Emperor Tiberius a dinner plate that was very light and almost bright as silver. The goldsmith told Emperor Tiberius that only he and the gods knew how to produce this metal from clay. Tiberius was one of the Rome's great generals who conquered most of Europe and amassed a fortune in gold and silver. He was also a financial expert who knew that the value of his fortune would decline if people suddenly had access to a shiny new metal that was rarer than gold. So, instead of giving the goldsmith expected regard, the Emperor ordered his beheading [62]. Although the story is most likely a legend, it implies that other metals besides Pb, Sn, Hg, and Fe may have been reduced.

3.3. Alchemy and the Middle Ages

Craftsmanship and alchemy are considered to be the basis for scientific research and development that unknowingly depended on phenomena such as thermodynamics and diffusion. Alchemy, the early science of material transmutation with a purpose of evocating a valuable changes, provided some accurate explanations for chemical and physical reactions. Alchemists developed and carefully recorded processes that yielded the desired changes in material properties. However, when they found no obvious explanation, the magic was accredited [63]. Although it was practiced in China, Near East and Greece, alchemy is most often associated with the Egyptians who developed initial formulas in the 1st century AD. From there, alchemy spread to Western Europe and was practiced during the Middle Ages. Improvements of different alchemical recipes for similar engineering processes were made possible by cultural overlapping due to warfare, travel and trade. The cuneiform codex not only lists the formulas and processes, but it also shows the differences between the Babylonian and Egyptian approaches to alloying and coating. While Babylonian approach to transmutation involved heating the metal in the bath, Egyptian transmutation was performed by immersing previously heated metal in the mixture of chemicals [12]. Although alchemists failed to transmute Al, alum was extensively used. The military application of alum is mentioned during the First Mithridatic war when Greek general Archelaus realised that *alu-* based solution can be used to treat wood in order to make it partially flame resistant. Parallely, his opponent Roman general Sulla used the same solution to protect the fleet from Archelaus attempts to set it on fire utilizing metallic mirrors [64]. The First Mithridatic War ended in Orchomenus where Sulla, using the terrains natural defences defeated Archelaus's more superior army [65]. In addition to its military purposes, alum was also used by tanners (lat. *alutarii*) to produce a special type of soft white leather (lat. *aluta*). The tanning effect was obtained through the weak reaction between alum salts and carboxyl groups in collagen proteins [66]. The Chinese alchemists used alum to make aqueous solutions used in metal surface processing. According to one of the recipes, to obtain a solution for surface treatment of Fe, it to mix transparent pieces of alum with horses' teeth in a green bamboo tube and add 4 measured of nitric acid. The opening is then tightly sealed, and a tube is immersed in vinegar for 30 days. Applying the obtained solution on the surface of Fe will result in the appearance of copper [67]. Besides metallurgical applications, alum is also mentioned in recipes concerning the elixir of life known as Golden flower. According to this recipe the cinnabar, mercury and alum are placed in the egg-shaped container made of silver. The container is heated in a mixture of Fe rust, Cu, S, realgar, saltpetre and honey. As expected, the procedure did not result in the elixir of life, but often resulted in serious hand and facial injuries as well as arson [68]. So it is not surprising that alchemy was considered tempering with Order of Creation and the attempt to conquer the Nature. This gave cautious and dangerous political and religious connotations leading to persecution. The religious persecution initiated in 3rd century when Roman Emperor Diocletian ordered the destruction of the

alchemic texts and codex. This drove the alchemic practices into secrecy marking it as “The Dark Arts”. Unfortunately, the dark connotation followed alchemy through Middle Ages associating it with evil, demonic, and occult practices. In this period the scientific work of all types that was not solely for medical purposes was considered heresy [69]. The believe that philosophical understanding or scientific approach were inspired by the devil ended in 15th century with the downing of the Renaissance. The beginnings of liberal thought and the development of new ideas are evident in the scientific theories and engineering innovations of Copernicus, Galileo, Leonardo da Vinci, Kepler, and Paracelsus. Fearing excommunication by the Catholic Church rather than execution, Renaissance sci-

entists abandoned the Greek ideas of alchemy and concentrated on mathematics and the natural sciences. This new approach to intellectual freedom led to a scientific revolution [70]. The Georgiou Agricola’s catalogue entitled *On the Nature of Metals* is considered to be one of the earliest Renaissance works representing the *state of the art* mining, refining and smelting. In his catalogue, Agricola describes alum production in 12th book together with salt, soda, vitriol, sulphur, bitumen, and glass. The alum, described as astringent and sharp solidified juice (*succi contracti*), was obtained from aluminous water or a solution containing “*kind of earth*”, rocks, pyrites and other minerals using hydrometallurgy (Fig. 6. a) or pyrometallurgy (Fig. 6. b) [71].



A – tanks, B – stirring poles, C – plug, D – trough, E – reservoir,
F – launder, G – lead cauldron, H – wooden tubs sunk into the
earth, I – vats in which twigs are fixed

a)



A – furnace, B – enclosed space, C – aluminous rock, D – deep
ladle, E – cauldron, F – launder, G - troughs

b)

Fig. 6. The alum extraction process by a) hydrometallurgy, b) pyrometallurgy [71]

Raw materials are placed in wooden tanks at the beginning of the hydrometallurgical process (Fig. 6. a, A) and mixed with water and urine. After the solution is mixed and stirred for several days (Fig. 6. a, B), the plugs (Fig. 6. a, C) are taken out and the solution is drawn into a wooden trough (Fig. 6. a, D). This alum-rich solution is transported into a reservoir (Fig. 6. a, E) and diluted with water and urine. After a few days of soaking the reservoirs are emptied using launders (Fig. 6. a, F) into a small lead cauldron (Fig. 6. a, G). The solution is boiled until most of the water has evaporated. The obtained solution is full

of meal consisting of fatty and aluminous matter as well as asbestos and gypsum impurities. Afterwards, the obtained solution can be cooled in a wooden tub (Fig. 6. a, H) or purified by running through the vats. The purification of the cooled solution containing alum is performed by running the solution through the vats containing twigs that enable alum crystallization (Fig. 6. a, I). At the end of the hydrometallurgical process, the small transparent white cubes of alum are placed in the hot rooms to dry. The pyrometallurgical process consists of roasting aluminous rocks in a furnace (Fig. 6. b, A) until they become

red in color and desulfurized. After roasting and cooling, the desulfurized rocks are conveyed into an open space (Fig. 6. b, B) to be sprinkled with water for four days. After moisturizing for a given time, the aluminous rocks began to crumble (Fig. 6. b, C). The obtained material is transported using deep ladles (Fig. 6. b, D) into a copper cauldron (Fig. 6. b, E) containing boiling water. After the solution is sufficiently purified and ready to congeal, it is ladled through the launders (Fig. 6. b, F) into the trough (Fig. 6. b, G). In wooden trough the solution congeals and condenses into the alum. When pyrites and other rock types are used, the alum is obtained pyrometallurgically after Au, Ag and Cu have been separated [71].

3.4. The discovery of aluminum

As a part of his new theory of oxygen combustion, Lavoisier proposed the idea that alumina (Al_2O_3) was an oxide of a metal with a high affinity for oxygen [72]. Alessandro Volta, an Italian physicist and chemist, found in 1800 that an electric current is produced when two metal electrodes are separated by an electrolyte solution (Fig. 7). Soon after, the possibility of utilizing Volta's invention in metal synthesis was recognized. The first attempts to obtain pure Al were made in 1807 by Berzelius and Humphry Davy (Fig. 7.).

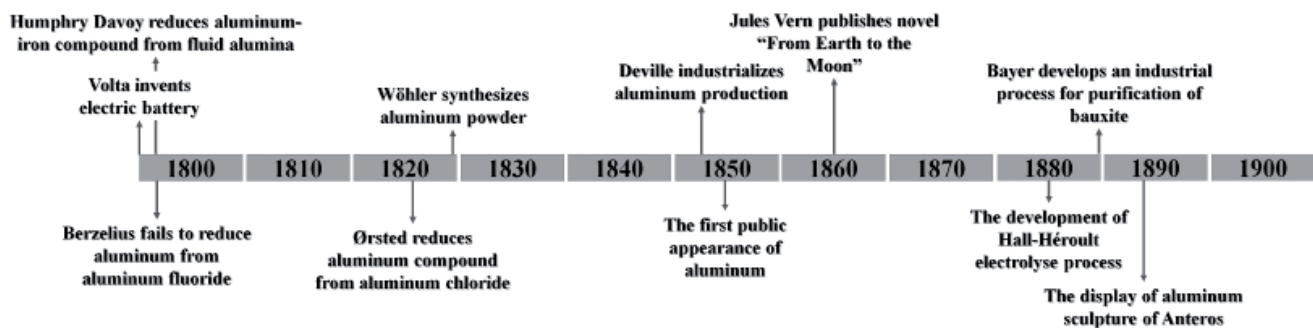

Fig. 7. The timeline of aluminum discovery, technological developments, and applications during 19th century [57]

Berzelius attempted to decompose Al, boron (B) and silicon (Si) from aluminum fluoride (AlF_3) using potassium amalgam (KHg_2). Unfortunately, his approach to Al extraction was unsuccessful due to the high solubility of Al in caustic potassium (K) produced during electrolysis. Had he used the excess amount of AlF_3 , Berzelius would be accredited for discovering Al. Thus, that merit belonged to his most famous student Friedrich Wöhler [73]. By introducing the molten compounds to an electric arch, Davy successfully produced pure K, sodium (Na), calcium (Ca), strontium (Sr), barium (Ba) and Mg. However, Davy was not able to synthesize pure Al. Instead, he synthesized Al-Fe alloy through electrochemical reactions in fluid alumina followed by carbon-based reduction. Although he used alumina in his experiments, Davy named this new element after alum, this "precious" and "bitter" white mineral [74]. First he spelled it *aluminium*, latter changing it to *aluminum*, while finally settling on *aluminium* in 1812.

While scientific community preferred aluminium due to its classical ring, the aluminum was adopted in the United States when metal began to be widely available. The name aluminium was finally standardized in the 1990 by The International Union of Pure and Applied Chemistry [75].

In 1825 Hans Christian Ørsted started to investigate the chemical action of the voltaic current and tried to electrochemically isolate the metal believed to reside in alumina. Firstly, Ørsted prepared aluminum chloride (AlCl_3) by passing a flow of chlorine (Cl) over a mixture of charcoal and alumina preheated to redness (Fig. 8).

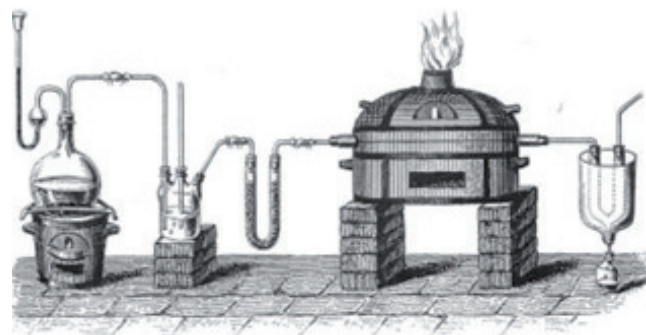

Fig. 8. Ørsted's apparatus for synthesis of dry aluminum chloride [76]

The obtained AlCl_3 was mixed and heated with KHg_2 , producing potassium chloride (KCl) and aluminum amalgam (Al(Hg)). By distilling Al(Hg) in the inert atmosphere, he was able to obtain metal that looked like Sn. At the end of experiment, Ørsted reported:

"This amalgam is very quickly decomposed in contact with the atmosphere. By distillation without contact with the atmosphere, it forms a lump of metal which in color and luster somewhat resembles tin. Moreover the author has found, both in the amalgam and the aluminum, remarkable properties which do not permit him to regard the experiments as complete, but show promising prospects of important results" [74].

Although Ørsted's contribution to Al discovery was not recognized by the scientific community of that time, Wöhler's discovery was based on the results of his experi-

ments. By repeating the Ørsted's experiment and reheating the synthesized mass, Friedrich Wöhler was able to indicate that the present impurities are mostly K-based originating from the reaction between diluted potassium amalgam and aluminum chloride [77]. Since Wöhler was not able to synthesize pure Al by relying on the previously established method, he prepared the AlCl_3 as indicated by Ørsted, and devised a new plan to isolate pure Al. This new plan was based on the decomposition of AlCl_3 using K and the stability of Al in water. After adding the excess amount of hot potassium carbonate (K_2CO_3) to a boiling hot solution of alumina, Wöhler was able to precipitate aluminum hydroxide ($\text{Al}(\text{OH})_3$). The precipitates were rinsed in water, dried and mixed with powder charcoal, sugar and oil into a thick paste. Upon heating this paste in the closed crucible and introducing dry Cl gas, Wöhler produced AlCl_3 . Since the AlCl_3 decomposition is too volatile for glass crucible, Wöhler used platinum (Pt) crucible and crucible cover. Although only gentle heat was applied to start the process, the exothermic reaction caused significant heat release and enabled crucible attacks. After cooling, the crucible was plunged into water allowing for the pure Al to be separated as a gray powder. The obtained Al powder contained K, Pt and AlCl_3 impurities. In 1845 he was able to successfully melt the powder into a coherent metallic mass no larger than a pinhead (Fig. 7.). Wöhler was able to synthesize beryllium and yttrium in the same manner [74]. Since his process was not suitable for large-scale production, Al remained an expensive metal that cost more than gold [57]. Pure Al was first synthesized when Henri-Etienne Sainte-Claire Deville became interested in the possibility of obtaining a lower aluminum oxide by reducing AlCl_3 with metallic K (Fig. 7.). He was not able to obtain the aluminum oxide, but he did produce a mixture of $\text{AlCl}_3 \cdot \text{KCl}$ containing voluminous globules of a "brilliant white metal" describing them as:

"It is understandable that a metal white and unalterable like Ag, that does not blacken in air, that is fusible, malleable, ductile, and tough, and that presents the particular

property of being lighter than glass (density = 2.56), how much useful such a metal would be if it would be possible to manufacture it easily. If in addition, we consider that this metal is abundantly present in nature, that its mineral is clay, it is desirable that it became common." [78]

Therefore, it is not surprising that after the initial success in Al synthesis, Sainte-Claire Deville set a goal to develop an industrial process for Al reduction. He was able to replace the K with cheaper Na and developed a process to reduce Al from less volatile solution of aluminum chloride and sodium chloride ($\text{AlCl}_3 \cdot \text{NaCl}$) salts. Later, Sainte-Claire Deville used the same $\text{AlCl}_3 \cdot \text{NaCl}$ salt to obtain the metallic Al by electrolysis. Although Deville's method enabled reduction of 200 metric tons of Al [79], synthesized metal was primarily used for jewelry and in ornamental purposes. Disillusioned by its luxurious application, Sainte-Claire Deville stated:

"There is nothing harder than to make people use a new metal. Luxury items and ornaments cannot be the only sphere of its application. I hope the time will come when aluminium will serve to satisfy the daily needs" [80].

The first book about Al was published in 1858 by Charles and Alexander Tissier. One year later in his science novel "From the Earth to the Moon" the French novelist Jules Vern used Al to construct his projectile Columbiad (Fig. 9. a) and shot it to the Moon (Fig. 9. b). In the 1867 Paris exhibition, Al sheet, foil, wire as well as helmets and telescopes were presented to the public [57]. One of the first architectural applications of Al was in 1884 when it was chosen to complete the Washington monument [80]. Based on his previous work on Al purification using sodium vapors, William Frishmuth was engaged. He was able to cast the largest piece of Al with a height of 20.23 cm and 2.83 kg in weight (Fig. 10.). Unfortunately, unlike his foundry skills, his business skills proved to be lacking. Before sending it to the Washington, Frishmuth displayed the cap in the Tiffany's jewelry store in New York City without permission.



a)



b)

Fig. 9. The illustrations of Jules Vern science novel "From the Earth to the Moon":

a) Columbiad, b) The firing of the Columbiad [81]

Moreover, instead of charging initial \$100, he increased the price to \$225. Two months after the cap was placed on top of the Monument (**Fig. 10. a**), Frishmuth found himself with additional Al left over from casting. By placing the advertisement in the journal *Scientific American*, he offered watch charms from pure Al for 75 cents, Al alloy charms for 20 cents or gilded Al alloy charms for 20 cents [82]. Like its creator's character, the purity of Al cap was also questionable. Investigations performed during its display in the jewelry store indicated that the cap was made of Al-1.70 wt.% Fe-0.55 wt.% Si alloy. Even after the cap was installed, Frishmuth was no prepared to part from his work. After a series of lightning strikes in 1885, Frishmuth offered to provide lightning-rod (**Fig. 10. b**).

Frustrated by his previous behavior, the clients led by Thomas Lincoln Casey flatly rejected his proposal hiring his competitor, Joseph Neumann. Unfortunately, drama did not stop there. Two of his assistants were caught in an attempted theft, one of whom was arrested and convicted for stealing chemicals worth \$2.50.

Looking back on the whole experience, Casey concluded that Al was not practical metal for widespread use just yet. Although Al did have its advantages, Casey emphasized the difficulty in getting even 100-ounce sample, finishing his account with words:

“would seem to imply that Aluminium cannot yet be manufactured at such rates as to make it a commercial success” [83].



a)

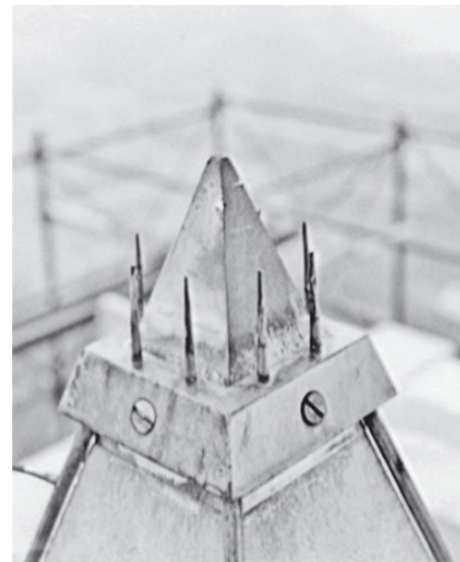

b)

Fig. 10. Topping of the Washington Monument:

a) illustration of placing the cap [83], b) cast Al cap with lightning-rods [84]

Ironically, less than two years after the Washington Monument was completed, the process for making Al cheap and commercially available was discovered [85].

The time of Al widespread application came with the discovery of more cost-effective electrolytic method. The electrolytic reduction of Al was discovered by Charles Hall and Paul Héroult, independently and almost simultaneously. Charles Martin Hall found that the melting temperature of alumina (2050 °C) could be lowered by adding cryolite (Na_3AlF_6) [86]. He assumed that passing electric current through that mixture could lead to the reduction of Al. His assumption was confirmed on 23rd of February 1886 when Al was first electrolyzed in an improvised laboratory in the woodshed using home-made batteries. His first electrolyzed Al in the form of buttons is up to this day treasured by Aluminum Company of America and referred to as crown jewels (**Fig. 11**) [74]. Paul Louis Toussaint Héroult was second to electrolyze Al from the same electrolyte mixture on April 23rd 1886 [86]. Apart from the differences in the electrode number and Al electrolysis cells design, the main difference is that Héroult



Fig. 11. The crown jewels of Aluminum Company of America [88]

preferred aluminum bronze over pure Al. Since his first experiments resulted in Al absorption on the surface of Cu cathode and increased metal coalescence, Héroult became aware that it was easier to produce aluminum bronze. However, in order to remain competitive to Hall, Héroult had to introduce changes in the pot lining and electrode pitch decreasing the current efficiency [87].

Even though Hall and Héroult met only once in 1911, the process for electrolytical production of primary Al bears both their names. The industrial scale application of Hall-Héroult process was enabled by the developments in electrical current supply and alumina production. The Bayer process boosted yield and practicality of Hall-Héroult method by producing alumina from bauxite ($\text{Al}_2\text{O}_3 \cdot \text{Fe}_2\text{O}_3 \cdot \text{SiO}_2 \cdot \text{TiO}_2$) more efficiently [79]. The modern production of Al is based on both Bayer and Hall-Héroult processes (Fig. 12.). Since 1919 the increase in pot productivity, reduction in specific energy consumption, reduced environmental impact as well as decrease in investment and productivity cost were achieved through invention of Søderberg anode, introduction of pot computer control, pot feeding of alumina, polyvalent pot tending machines, pot hooding and gas dry scrubbing, mathematical modelling of pot thermo-electrical fields and magnetohydrodynamics [89]. Despite technological and process improvements the industrial production of primary Al still requires 14.21 MWh/tonne energy intensity and accounts for approximately 3.5 % of direct global greenhouse gas emissions (GHG) in the industrial sector. This environment impact is a consequence of electricity use, anode consumption and anode effect [90].

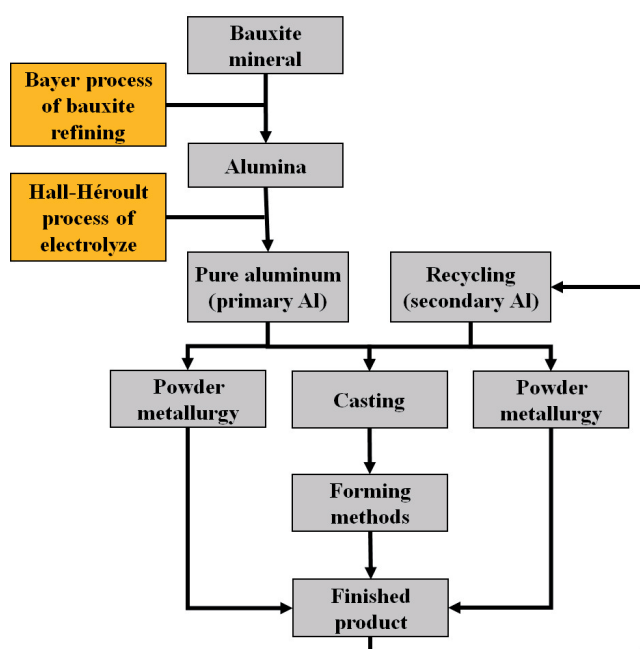

Fig.12. Flow chart of Al production process [57]

Recycling is considered an alternative to primary Al production. Compared to other high-volume production metals, such as Cu, Zn, and Mg, Al has the largest energy difference between primary and secondary production. Production of secondary Al through recycling allows for 95 % energy reduction and emits only 5 % of the GHG

compared to primary Al reduction [58]. By producing 1 t of secondary Al, the 8 t of bauxite, 14 000 kWh of energy, 6300 l of oil and 7.6 m³ of landfill are saved. However, assuring the required chemical composition remains the main obstacle to secondary Al production [91]. The first commercially available Al-Mg-Si alloy was developed in 1921, while the first heat-treatable Al alloy of the same type (AA 6061) was introduced in 1935. Due to good weldability and corrosion resistance, it was popular in early railroad and marine applications. From that moment Al became more just than a single material and developed into a diversity of alloys with different physical, chemical and mechanical properties [57]. Consequently, at the beginning of the 1960s Al became the most widely used non-ferrous metal in the world [92]. Today, Al is still considered an attractive material with many applications, including automotive, aerospace, railway, marine, electric, and architectural. The Al alloys continue to develop and slowly begin to include specific scientific and technological applications such as 3D printing and composite material industry. Based on the excellent properties of Al in combination with low price, significant scrap value and growing recycling market, the Al industry is expected to grow through the 21st century. Consequently, additional research and development efforts are needed to minimize the negative environmental impact associated with both primary Al production as well as industrialization of human society in general [92]. Therefore, it is not surprising that Alfred Gilbert decided to name his aluminum sculpture after the Greek god Anteros (Fig. 13.), who, unlike his brothers Eros and Cupid, reflects mature and selfless love. The sculpture was displayed at Piccadilly Circus in London as a memorial statue to the Earl of Shaftesbury [93].



Fig.13. Anteros topping the Shaftesbury Memorial Fountain at Piccadilly Circus in London, England [93]

4. Conclusions

This paper emphasizes the importance of metalworking and metallurgy through their impact on the development of human society with a focus being primarily placed on the discovery of aluminum and the challenges repre-

sented by the complex nature of aluminum-containing minerals. Although man's first contact with native copper and meteoritic iron was mostly artistic resulting in ornaments and jewelry, the first practical application of metals began with the development of bronze. Due to its better properties and easier shaping in comparison to the stone and bone, bronze began to be used in tool making. The first bronze, as an alloy produced by adding tin to copper, has a predecessor of approximately the same hardness and strength in the so-called arsenic or antimony copper, or as many consider arsenic/antimony bronze, which as a formation was created from a complex ore - tennantite $((\text{Cu,Fe})_{12}\text{As}_4\text{S}_{13})$ and tetrahedrite $((\text{Cu,Fe})_{12}\text{Sb}_4\text{S}_{13})$. Furthermore, the experimentation with bronze chemical composition led to the development of metallurgical processes such as smelting, refining and casting as well as mechanisms of economics and communication. When smelting copper ore, iron ore was used as a fluxing material. The resulting slag contained spongy iron. That was one of the theories of iron discovery. Soon after iron replaced bronze as a principal metal inspiring Industrial Revolution. To the world struggling to produce cheap steel, aluminum came to be known through the works of Wöhler and Deville. However, this brilliant white metal was primarily used for jewelry and for ornamental purposes, till it was first electrolyzed in a woodshed using home-made batteries on February 23rd 1886 by Charles Martin Hall. Few months later, the similar procedure was developed by Paul Louis Toussaint Héroult. Even though Hall and Héroult met only once in 1911, the process for electrolytic production of primary Al bears both their names and is still used today. Due to its late discovery as well as the necessity for interdisciplinary engineering and scientific approach to the development of industrially viable processes of extraction, reduction and manufacturing, aluminum is considered as a symbol of modernity. In today's society aluminum has many applications, including automotive, aerospace, railway, marine, electric, and architectural. This conclusion ends with a question as what if the early men did not have curiosity or necessity to discover metal? How would contemporary society look like if it was limited to stone, bone, and wood?

5. Acknowledgment

The investigation was performed within the research topic "Design and Characterization of Innovative Engineering Alloys," Code: FPI-124-ZZB funded by the University of Zagreb within the Framework of Financial Support of Research, and Education and Infrastructural scientific projects: Center for Foundry Technology, Code: KK.01.1.1.02.0020 and VIRTULAB — Integrated Laboratory for Primary and Secondary Raw Materials, Code: KK.01.1.1.02.0022 funded by the European Regional Development Fund, Operational Programme Competitiveness and Cohesion 2014–2020.

References

[1] Skowroński, A. A civilization based on sustainable development: Its limits and prospects. *Sustain. Dev.* 16 (2008) 117-125.

- [2] Armstrong, P.J., Kapp, H.A. Preserving the past or past preserving: sustaining the legacy of postmodern museum architecture. *Built Herit.* 6(2022).
- [3] Hodder, I. *The Present Past: An Introduction to Anthropology for Archeologists.* Pen and Sword Archaeology, Barnsley, 2012, pp. 1-240.
- [4] Grassby, R. Material Culture and Cultural History. *J. Interdiscip. Hist.* 35 (2005) 591-603.
- [5] Yoo, I., Yi, C.G. Economic Innovation Caused by Digital Transformation and Impact on Social Systems. *Sustain.* 14 (2022) 1-18.
- [6] Woodfield, P.J., Husted, K. Sharing Knowledge Across Generations and Its Impact on Innovation. *Wine Bus. J.* 5 (2022) 88-103.
- [7] Fitzhugh, B. Risk and Invention in Human Technological Evolution. *J. Anthropol. Archaeol.* 20 (2001) 125-167.
- [8] Siregar, I., Zulkarnain. The Relationship between Conflict and Social Change in the Perspective of Expert Theory: A Literature Review. *Int. J. Arts Humanit. Stud.* 2 (2022) 9-16.
- [9] Gasper, K. When necessity is the mother of invention: Mood and problem solving. *J. Exp. Soc. Psychol.*, 39 (2003) 248/262.
- [10] Smith, C.S. Metallurgy as a human experience. *Metall. Trans. A*, 6 (1975) 603-623.
- [11] Wertime, T.A. The Beginnings of Metallurgy: A New Look. *Science.* 182 (1973) 875-887.
- [12] Forrester, R. History of Metallurgy. In: Forrester, R. (ed) *How Change Happens: A Theory of Philosophy of History, Social Change and Cultural Evolution.* est Publications Limited, New Zealand, 2019, pp.1-9.
- [13] Maxwell-Hyslop, R. The Metals amütu and ašī'u in the Kültepe Texts. *Anatol. Stud.* 22 (2013) 159-162.
- [14] Matsui, T., Moriwaki, R., Zidan, E., Arai, T. The manufacture and origin of the Tutankhamen meteoritic iron dagger. *Meteorit. Planet. Sci.* 57 (2022) 747-758.
- [15] Werl, T.A. Man's First Encounte With Metallur. *Science.* 146 (1964) 1257-1267.
- [16] Valério, P., Vidigal, R.O., Araújo, M.F., Soares, A.M.M., Silva, R.J.C., Mataloto, R. Manufacture of copper weapons and tools from the chalcolithic settlement of São Pedro (Portugal). *Mater. Manuf. Process.* 32 (2017) 775-780.
- [17] Klimscha, F. Power and Prestige in the Copper Age of the Lower Danube. In: Stefan, C.E., Florea, M., Ailincăi, S.C., Micu, C. (eds) *Studies in Prahistory of Southeastern Europe.* Institutul de Cercetări Eco-Muzeale, Romania, 2014, pp. 131-168.
- [18] Wertime, T.A. Pyrotechnology: Man's First Industrial Uses of Fire: The Neolithic Revolution introduced man to the new energy resources to be had from agriculture and those to be gained by applying fire to fuels and earths. *American Scientist.* 61 (1973) 670-682.
- [19] Kądziołka, K., Pietranik, A., Kierczak, J., Potysz, A., Stolarczyk, T. Towards better reconstruction of smelting temperatures: Methodological review and the case of historical K-rich Cu-slugs from the Old Copper Basin, Poland. *J. Archaeol. Sci.* 118 (2020).
- [20] Gheorghiu, G. *Fire as an Instrument: The Archaeology of Pyrotechnologies.* BAR Publishing, Oxford, 2007, pp. 33-41
- [21] Bentsen, S.E. Controlling the heat: An experimental approach to Middle Stone Age pyrotechnology. *South African Archaeol. Bull.* 68 (2013) 137-145.

- [22] Roberts, B.W., Radivojević, M. Invention as a process: Pyrotechnologies in early societies. *Cambridge Archaeol. J.* 25 (2015) 299-306.
- [23] <https://www.cambridge.org/engage/coe/contact-information?show=faqs> (9.1.2023.)
- [24] Wertim, T.A. A metallurgical expedition through the Persian desert. *Science.* 159 (1968) 927-935.
- [25] Haldar, S.K. *Mineral Exploration: Principles and Applications.* Elsevier publications, Amsterdam, 2018, pp. 58-101.
- [26] Dill, H.G. Pyrometallurgical relics of Pb-Cu-Fe deposits in south-eastern Germany: An exploration tool and a record of mining history. *J. Geochemical Explor.* 100 (2008) 37-50.
- [27] Benvenuti, M., Costagliola, P., Tanelli, G. Iron, copper and tin at Baratti (Populonia): smelting. *Hist. Metall.* 34 (2000) 67-76.
- [28] URL: <http://donwagner.dk/EARFE/EARFE.html> (9.1.2023).
- [29] Nriagu, J.O. Cupellation: The oldest quantitative chemical process. *J. Chem. Educ.* 62 (1985) 668-674.
- [30] Erel, Y., Pinhasi, R., Coppa, A., Ticher, A., Tirosh, O., Carmel, L. Lead in Archeological Human Bones Reflecting Historical Changes in Lead Production. *Environ. Sci. Technol.* 55 (2021) 14407-14413.
- [31] Lechtman, H. Arsenic bronze: Dirty copper or chosen alloy? A view from the Americas. *J. F. Archaeol.* 23 (1996) 477-514.
- [32] Muhly, J.D. Sources of Tin and the Beginnings of Bronze Metallurgy. *Am. J. Archaeol.* 89 (1985) 275-291.
- [33] Pigott, V.C. The acquisition of tin in Bronze Age southwest Asia. In: Lyonnet, B., Dubova, N. (eds). *The World of the Oxus Civilization*, Routledge, England, 2020, pp. 827-861.
- [34] Svizzero, S., Svizzero, S., Controversies, P., Revolution, N. Persistent Controversies about the Neolithic Revolution. *J. hist. archaeol. anthropolog. sci.* 1 (2017).
- [35] Lazić, L., Zovko Brodarac, Z. Povijesni pregled metalurških aktivnosti na tlu Republike Hrvatske, *Annu. Croat. Acad. Eng.* 1 (2020).
- [36] Zardabil, I. *THE HISTORY OF AZERBAIJAN: from ancient times to the present day.* Ministry of Education Republic of Azerbaijan, London, 2004, pp. 91-131.
- [37] Earle, T., Ling, J., Uhnér, C., Stos-Gale, Z., Melheim, L. The Political Economy and Metal Trade in Bronze Age Europe: Understanding Regional Variability in Terms of Comparative Advantages and Articulations. *Eur. J. Archaeol.* 18 (2015) 633-657.
- [38] Skowronek, R.K. *Archival Research and Historical Archaeology.* In: Smith, C. (ed). *Encyclopedia of Global Archaeology.* Springer New York, New York, 2014, pp. 492-495.
- [39] Knight, J., Harrison, S. A land history of men: The intersection of geomorphology, culture and heritage in Cornwall, southwest England. *Appl. Geogr.* 42 (2013) 186-194.
- [40] Brysbaert, A. Painted plaster from Bronze Age Thebes, Boeotia (Greece): a technological study. *J. Archaeol. Sci.* 35 (2008) 2761-2769.
- [41] Kassianidou, V., Knapp, A.B., *Archaeometallurgy in the Mediterranean: The Social Context of Mining, Technology, and Trade.* In: Blake, E., Knapp, B. (eds) *The Archaeology of Mediterranean Prehistory.* Blackwell Publishing Ltd, New Jersey, 2008, pp. 215-251.
- [42] Williams, A. *The Knight and the Blast Furnace: A History of the Metallurgy of Armour in the Middle Ages and the Early Modern Period.* Brill, Leiden, 2004, pp. 1177-1178.
- [43] Evans, C., Rydén, G. *The Industrial Revolution in Iron: The Impact of British Coal Technology in Nineteenth-Century Europe.* Routledge, Oxfordshire, 2017, pp. 1-14.
- [44] Casella, E., Nevell, M., Steyne, H. *The Oxford Handbook of Industrial Archaeology.* Oxford University Press, Oxford, 2022, pp. 110-128.
- [45] Holappa, L. Historical overview on the development of converter steelmaking from Bessemer to modern practices and future outlook. *Miner. Process. Extr. Metall. Trans. Inst. Min. Metall.* 128 (2019) 3-16.
- [46] Cottrell, A. *An Introduction to Metallurgy.* Routledge, Oxfordshire, 1997, pp. 94-107.
- [47] Gordon, R. Issues in the introduction of tonnage steel in the United States, 1867-1883. *Hist. Metall.* 45 (2011) 42-51.
- [48] Robertson, T.D. Electric steel-making furnaces. *J. Inst. Electr. Eng.* 53 (1915) 533-539.
- [49] Wcislik, M. Sustainable development and ecological aspects in electric steelmaking process evolution. 2017 International Conference on Electromagnetic Devices and Processes in Environment Protection with Seminar Applications of Superconductors (ELMECO & AoS), Naleczow, Poland, 2017, pp. 1-4.
- [50] Dennis, H.V. *Metallurgy: 1863-1963.* Routledge, Oxfordshire, 2010, pp. 110-125.
- [51] URL: <https://international-aluminium.org/statistics/primary-aluminium-production/> (19.1.2023.).
- [52] URL: <https://international-aluminium.org/resource/production-reporting-guidelines-aluminium/> (20.1.2023.).
- [53] Rambabu, R., Prasad, N.E., Kutumbarao, V.V., Wanhill, R.J., *Aerospace Materials and Material Technologies,* Springer, Flevoland, 2017, pp. 29-53.
- [54] Bobruk, E.V., Murashkin, M.Y., Ramazanov, I.A., Kazykhanov, V.U., Valiev, R.Z., *Low-Temperature Superplasticity and High Strength in the Al 2024 Alloy with Ultrafine Grains.* *Materials,* 16 (2023) 1-10.
- [55] Tiwary, A., Kumar, R., Chohan, J.S. A review on characteristics of composite and advanced materials used for aerospace applications. *Mater. Today Proc.* 51 (2021) 865-870.
- [56] Gendron, R.S., Ingulstad, M., Storli E. *Aluminum ore: the political economy of the global bauxite industry.* UBC Press, Vancouver, 2014, pp. 268-302.
- [57] Ashkenazi, D. How aluminum changed the world: A metallurgical revolution through technological and cultural perspectives *Technol. Forecast. Soc. Change.* 143 (2019) 101-113.
- [58] Kirby, R.S., Withington, S., Darling, A.B., Kilgour, K.G. *Engineering in History.* Bover Publications, New York, 2013, pp. 6-36
- [59] Augustin M., Pellò, C. Life and Lifeforms in Early Greek Atomism. *Apeiron.* 55 (2022) 601-625.
- [60] Marinca, A. Aristotle's Criticism of Presocratic Theories of Continuity in *Physics VI.* *Hermeneia.* 28 (2022) 38-51.
- [61] Giumlia-Mair, A. Alum in Ancient Metallurgy. In: Borgard, P., Brun, J.P., Picon, M. (eds) *L'alun de Méditerranée.* Publications du Centre Jean Bérard, France, 2016, pp. 335-341.
- [62] URL: <http://www.perseus.tufts.edu/hopper/text?doc=Perseus%3Atext%3A1999.02.0137%3Abook%3D35%3Achapter%3D52> (24.1.2023).
- [63] Smith, P.H. *The Business of Alchemy.* Princeton University Press, Princeton, 2019, pp. 173-227.
- [64] URL: <https://publications.iafss.org/publications/fss/1/761/view>

- /fss_1-761.pdf (24.1.2023.).
- [65] Matyszak, P. The Mithridatic Wars, 89-66 BC. In: Whitby, M., Sidebottom, H. The Encyclopedia of Ancient Battles. John Wiley & Sons, New York, 2017, pp. 1-13.
- [66] Elnaggar, A., Leona, M., Nevin, A., Heywood, A. The Characterization of Vegetable Tannins and Colouring Agents in Ancient Egyptian Leather from the Collection of the Metropolitan Museum of Art. *Archaeometry*. 59 (2017) 133-147.
- [67] Holmyard, E.J. Obituary Frank Sherwood Taylor (1897-1956). *Ambix*. 5 (1956) 57-58.
- [68] URL: <https://www.teeswildlife.org/what-we-do/past-projects/alum-alchemy-and-ammonites/alum/alum-history/> (26.1.2023.)
- [69] Matus, Z.A. Alchemy and Christianity in the Middle Ages. *Hist. Compass*. 10 (2012) 934-945.
- [70] Moran, B.T. *Distilling Knowledge: Alchemy, Chemistry, and the Scientific Revolution*. Harvard University Press, USA, 2005, pp. 132-156.
- [71] URL: <https://www.gutenberg.org/files/38015/38015-h/38015-h.htm> (24.1.2023.).
- [72] Crosland, M. Lavoisier, the two French revolutions and the imperial despotism of oxygen. *Ambix*. 42 (1995) 101-118.
- [73] Holmes, H.N. Fifty Years of Industrial Aluminum. *The Scientific Monthly*. 42 (2014) 236-239.
- [74] Weeks, M.E. *Discovery of the Elements*. Kessinger Publishing, LLC, SAD, 2010, pp.343-361
- [75] Kvande, H. Two hundred years of aluminum... or is it aluminium?. *Jom*. 60 (2008) 23-24.
- [76] URL: <https://sciencenordic.com/chemistry-denmark-science-history/h-c-orsted-discovered-aluminium-but-he-did-not-take-his-discovery-seriously/1674429> (27.1.2023.).
- [77] URL: <https://royalsocietypublishing.org/doi/10.1098/rspl.1843.0040> (27.1.2023.).
- [78] Wisniak, J. Henri Étienne Sainte-Claire Deville: A Physician Turned Metallurgist. *J. Mater. Eng. Perform.*, 13 (2004) 117-128.
- [79] Kvande, H. The aluminum smelting process. *J. Occup. Environ. Med*. 56 (2014) 2-4.
- [80] Runge, J.M. A Brief History of Aluminum and Its Alloys. *The Metallurgy of Anodizing Aluminum*. February (2018) 1-63.
- [81] URL: https://docs.lib.purdue.edu/cgi/viewcontent.cgi?article=1045&context=purduepress_previews (27.1.2023.)
- [82] Asm, A., Landmark, H. The Cast Aluminum Cap on the Washington Monument. *Metallogr. Microstruct. Anal.* 1 (2012) 3-4.
- [83] URL: <https://www.archives.gov/files/publications/prologue/2014/summer/aluminum.pdf>. Lockwood (27.1.2023.)
- [84] Skrabec, Q.R. *Aluminum in America: A History*. Mcfarland & Company, Inc., SAD, 2017.
- [85] URL: <https://www.nps.gov/articles/000/wamocap.htm> (31.1.2023.).
- [86] Reverdy, M., Potocnik, V. History of Inventions and Innovations for Aluminum Production. *Miner. Met. Mater. Ser.* June (2022) 1895-1910.
- [87] Haupin, V. History of Electrical Energy Consumption by Hall-Heroult cells. In: Peterson, W.S., Mille, R.E. (eds). *Hall-Héroult Centennial. The Minerals, Metals and Materials Society*, Pittsburg, 2007, pp.106-113,
- [88] URL: <https://www.pittsburghmagazine.com/a-history-of-pittsburgh-in-50-artifacts/> (31.1.2023.).
- [89] Tarcy, G.P., Kvande, H., Tabereaux, H. Advancing the industrial aluminum process: 20th century breakthrough inventions and developments. *Jom*. 36 (2011) 101-108.
- [90] Haraldsson, J., Johansson, M.T. Effects on primary energy use, greenhouse gas emissions and related costs from improving energy end-use efficiency in the electrolysis in primary aluminium production. *Energy Effic.* 13 (2020) 1299-1314.
- [91] Sevigné-Itoiz, E., Gasol, C.M., Rieradevall, J., Gabarrell, X. Environmental consequences of recycling aluminum old scrap in a global market. *Resour. Conserv. Recycl.*, 89 (2014) 94-103.
- [92] Rabinovich, D. The allure of aluminium. *Nat. Chem.* 5 (2013) 76.
- [93] URL: <https://www.davidcastleton.net/eros-piccadilly-circus-statue-anteros-shaftesbury/> (31.1.2023.).